

# conference collection

Conference Table and Training Table selections are available in many options. Details of the table tops are provided for each series below. Specifications are found in each of the applicable series. For **Training Tables**, see **P. 157**.

## Product Specifications

### COLORS

- 20 standard colors are available. Two colors may be specified at no charge. (Except for premium colors)
- See color chart for color availability and color upcharges information.

TOPS (EDGE BAND)  and  3 DAYS LEAD TIME

### MAVERICK SERIES

- Conference table tops have a 1 $\frac{3}{4}$ " built-up edge.
- 2mm PVC edge band.
- 1 $\frac{3}{4}$ "-thick thermally fused melamine (TFM) built-up top.
- Rectangular and Boatshape tables feature radius corners.
- Round tables are 1" thick.
- Training table tops 1" thick, radius corners.

### ARROYO SERIES

- 2mm PVC edge banding.
- 1"-thick thermally fused melamine (TFM).
- Boatshape and Rectangular tables feature square corners.
- Square tables are 1" thick, square corners.
- Training table tops are 1" thick, square corners.

### APEX SERIES

- 2mm PVC edge banding.
- 1 $\frac{3}{4}$ "-thick thermally fused melamine (TFM) built-up top.
- Boatshape and Rectangular tables feature square corners.

### CANYON SERIES

- 1" thick tops have a "floating" appearance created by an inset "undertop trim 3/4" banded in a choice of silver or black color.
- Grooved Edge Top.

## LEGS AND BASES

- See wide range of options on pages 136.
- Attachment of legs to tops is either by metal-to-metal connection or by use of "L" brackets and wood screws.
- Conference table tops are provided with 7"H. Stretcher, with ARLEGA\_\_ or MMLEGA\_\_.

**Note:** Dimensions assigned in this price list are nominal. If exact measurements are required, the requirement must be specified in the order and specifically acknowledged by Maverick. Maverick reserves the right to change.

**Line Drawings shown are a resemblance to finish product. Product Designs may vary.**

**Discounts are different between factories.**

### Edge Detail (MM)

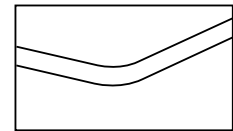

### Edge Detail (AR)

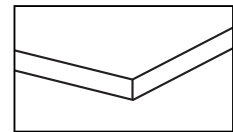

### Edge Detail (AP)

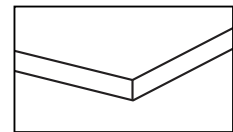

### Edge Detail (CY)

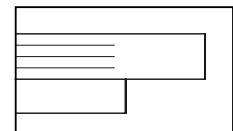

# conference collection

## How to Order Conference Collection - Tables and Bases

### WORKSURFACE UNITS

1. Product number: **MM BS 42 96**

Width (Table)  
Depth (Table)

Product Type: Conference Boatshape  
Series Name: Maverick

### CORNER SHAPE

Maverick Series



Arroyo Series | Apex



Canyon Series

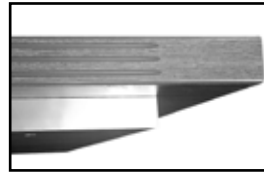

- Specify worksurface color.
- Specify worksurface edge color. Matching color is standard.
- Specify choice of base. See page 142-148 for options and prices.

**NOTE:** Prices for tops do not include prices for base(s). See Base Placement Chart for quantity needed. Edge detail varies by series.

### BASE OPTIONS

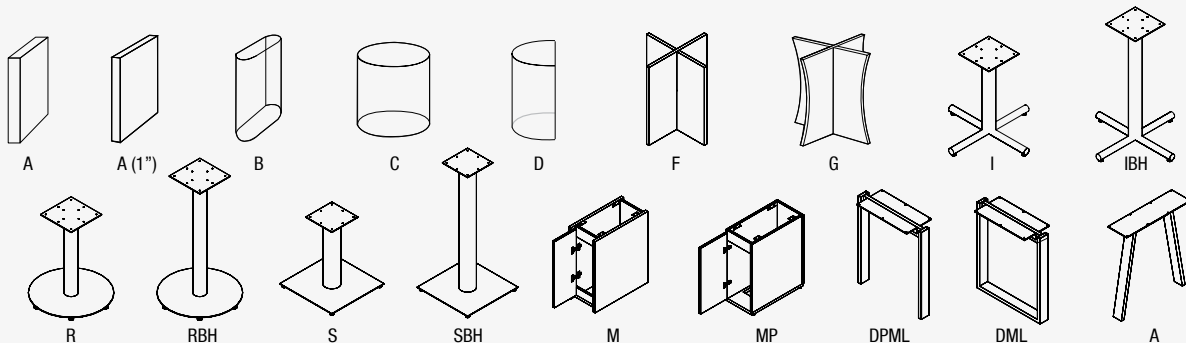

Leg Style	Leg   Base Description	(36"D)	(42"D)	(48"D)
MMLEGA	Square Panel Legs (ea.)	20" = \$169	24" = \$169	24" = \$169
ARLEGA	Square Panel Legs 1" (ea.)	20" = \$77	24" = \$77	24" = \$77
MMLEGB	Radius Panel Legs (ea.)	20" = \$302	24" = \$302	24" = \$302
MMLEGC	Cylinder Base (ea.)	20" = \$605	24" = \$701	24" = \$701
MMLEGD	Half-Cylinder Base (ea.)	20" = \$551	24" = \$648	24" = \$648
MMLEGF	Flat Panel X Base (ea.)	20" = \$269	24" = \$302	24" = \$371
MMLEGG	Sculpted Panel X Base (ea.)	20" = \$347	24" = \$381	24" = \$381
MMLEGI	Four Star Metal Base (ea.)	30" = \$540	30" = \$540	36" = \$587
MMLEGIBH	Four Star Metal Base Bar Hgt. (ea.)	30" = \$641	30" = \$641	36" = \$688
MMLEGR	Round Disc Base, Desk Hgt. (ea.)	24" = \$1,080	24" = \$1,080	24" = \$1,080
MMLEGRBH	Round Disc Base, Bar Hgt. (ea.)	24" = \$1,178	24" = \$1,178	28" = \$1,354
MMLEGS	Square Metal Base, Desk Hgt. (ea.)	20" = \$1,080	30" = \$1,238	30" = \$1,238
MMLEGSBH	Square Metal Base, Bar Hgt. (ea.)	20" = \$1,178	30" = \$1,354	30" = \$1,354
MMLEGM	Square Panel Base w/End Door (ea.)	20" = \$459	24" = \$485	24" = \$485
MMLEGMP	Square Panel Base w/End Door & Plinth Base (ea.)	20" = \$802	24" = \$824	24" = \$824
APLEGA	A-Frame Metal Leg (ea.)	20" = \$470	24" = \$514	24" = \$514
APDPML	Shared Double Post Leg	20" = \$420	24" = \$464	24" = \$464
APDML	Shared D-Leg	20" = \$524	24" = \$544	24" = \$544

# conference collection

## Statement of Line

### CONFERENCE



Conference | Boatshape  
(MMBS)



Conference | Racetrack  
(MMRT)



Conference | Rectangular  
(MMRE)



Conference | Rectangular (Canyon)  
(CYRE)



Conference | Rectangular  
(AP)



Conference | Round  
(RD)



Square Top  
(SQ)



Community Table  
(MM or CY)



Cube Table  
(MM)

## The Maverick Solution for the Conference Room

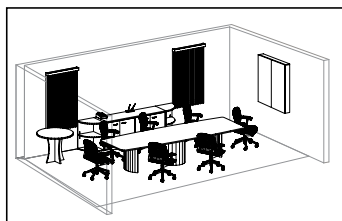

## Choosing the Right Table - The Maverick Solution

### ► Select your function/size

**Round Tables** = For smaller, more informal spaces and fewer people:  
36" for 3 seats, 42" for 4 seats, 48" for 5 seats, 54" for 6 seats.

**Rectangular, Boat-shape, Racetrack** = For larger spaces and more seats:  
72" or 84" for 6 seats; 96", 108", 120" for 8 seats; 144" for 12 seats.

### ► Select your style

**Table Top Shape** = Boat-shape, Racetrack, Rectangular, Round, Square.

**Table Series Style** = Edge Banded Maverick, Arroyo or Apex Series, Canyon grooved edge.

**Table Top Color** = From 20 standard colors - mix or match two colors, including top edge color.

**Base Style** = Sq. Panel, cylinder, power bases, metal bases, etc., see pages 142-148.

**Base Color** = Select from 20 standard colors. (Limited HPL colors)

# conference collection

## Maverick Series - Conference Table Tops

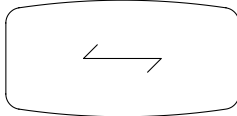

Boatshape Conference Table Top (1 3/4" thick build up edge, radius corners)

Model#	Depth	Width	Height	Top	Weight	Cube	Price
MMBS3672	30" / 36"	72"	1 3/4"	1 pc	122	3	\$689
MMBS4284	36" / 42"	84"	1 3/4"	1 pc	156	4	\$791
MMBS4296	36" / 42"	96"	1 3/4"	1 pc	176	4	\$890
MMBS42120	36" / 42"	120"	1 3/4"	1 pc	214	6	\$1,109
MMBS48120	42" / 48"	120"	1 3/4"	1 pc	237	6	\$1,328
MMBS42144	36" / 42"	144"	1 3/4"	2 pcs	273	7	\$1,831
MMBS48144	42" / 48"	144"	1 3/4"	2 pcs	302	7	\$1,932

**MAVEAST ONLY:** Tops width of 120" are made in 2-piece top, requires 3 bases.  
**MAVWEST:** Tops width of 120" are made in 1-piece top.

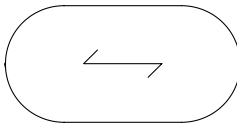

Racetrack Conference Table Top (1 3/4" thick build up edge)

Model#	Depth	Width	Height	Top	Weight	Cube	Price
MMRT3672	36"	72"	1 3/4"	1 pc	122	3	\$806
MMRT4284	42"	84"	1 3/4"	1 pc	156	4	\$939
MMRT4296	42"	96"	1 3/4"	1 pc	176	4	\$1,042
MMRT42120	42"	120"	1 3/4"	1 pc	214	6	\$1,194
MMRT48120	48"	120"	1 3/4"	1 pc	237	6	\$1,428
MMRT42144	42"	144"	1 3/4"	2 pcs	273	7	\$2,015
MMRT48144	48"	144"	1 3/4"	2 pcs	302	7	\$2,184

**MAVEAST ONLY:** Tops width of 120" are made in 2-piece top, requires 3 bases.  
**MAVWEST:** Tops width of 120" are made in 1-piece top.

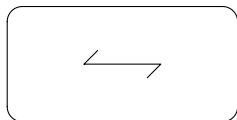

Rectangular Conference Table Top (1 3/4" thick build up edge, radius corners)

Model#	Depth	Width	Height	Top	Weight	Cube	Price
MMRE3672	36"	72"	1 3/4"	1 pc	122	3	\$654
MMRE4284	42"	84"	1 3/4"	1 pc	156	4	\$689
MMRE4296	42"	96"	1 3/4"	1 pc	176	4	\$822
MMRE4896	48"	96"	1 3/4"	1 pc	194	5	\$1,269
MMRE42120	42"	120"	1 3/4"	1 pc	214	6	\$1,075
MMRE48120	48"	120"	1 3/4"	1 pc	237	6	\$1,328
MMRE42144	42"	144"	1 3/4"	2 pcs	273	7	\$1,709
MMRE48144	48"	144"	1 3/4"	2 pcs	302	7	\$1,849
MMRE42168	42"	168"	1 3/4"	2 pcs	312	8	\$2,388
MMRE48168	48"	168"	1 3/4"	2 pcs	345	9	\$2,498
MMRE42192	42"	192"	1 3/4"	2 pcs	351	9	\$2,567
MMRE48192	48"	192"	1 3/4"	2 pcs	388	10	\$2,694
MMRE60120	60"	120"	1 3/4"	1 pcs	282	8	\$1,615
MMRE60144	60"	144"	1 3/4"	2 pcs	361	9	\$2,573
MMRE60168	60"	168"	1 3/4"	2 pcs	412	11	\$2,757
MMRE60192	60"	192"	1 3/4"	2 pcs	463	12	\$2,942

**MAVEAST ONLY:** Tops width of 120" are made in 2-piece top, requires 3 bases.  
**MAVWEST:** Tops width of 120" are made in 1-piece top.  
 Tops \*MMRE42168 - \*MMRE60192 require 2 LEAD TIME.

## Round Table Tops

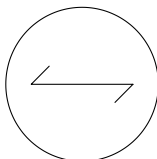

Round Table Table Top (1" thick)

Model#	Depth	Width	Height	Bases(Required)	Weight	Cube	Price
MMRD36	36"	36"	1"	1	36	1	\$472
MMRD42	42"	42"	1"	1	49	1	\$572
MMRD48	48"	48"	1"	1	64	2	\$722
MMRD54	54"	54"	1"	1	80	2	\$822
MMRD60	60"	60"	1"	1	99	2	\$1,091

**REMINDER:** Prices are for TOPS ONLY - Order legs/bases separately.

# conference collection

## Arroyo Series - Conference Table Tops

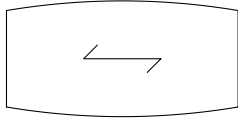

Boatshape Conference Table Top (1" thick top, square corners)

Model#	Depth	Width	Height	Top	Weight	Cube	Price
ARBS3672	30"/36"	72"	1"	1 pc	72	2	\$553
ARBS4284	36"/42"	84"	1"	1 pc	97	2	\$654
ARBS4296	36"/42"	96"	1"	1 pc	111	3	\$737
ARBS42120	36"/42"	120"	1"	1 pc	139	3	\$1,119
ARBS48120	42"/48"	120"	1"	1 pc	158	4	\$1,194
ARBS42144	36"/42"	144"	1"	2 pcs	166	4	\$1,575
ARBS48144	42"/48"	144"	1"	2 pcs	190	4	\$1,661

**MAVEAST ONLY:** Tops width of 120" are made in 2-piece top, requires 3 bases.  
**MAVWEST:** Tops width of 120" are made in 1-piece top.

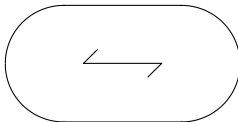

Racetrack Conference Table Top (1" thick top)

Model#	Depth	Width	Height	Top	Weight	Cube	Price
ARRT3672	36"	72"	1"	1 pc	72	2	\$572
ARRT4284	42"	84"	1"	1 pc	97	2	\$671
ARRT4296	42"	96"	1"	1 pc	111	3	\$757
ARRT42120	42"	120"	1"	1 pc	139	3	\$1,142
ARRT48120	48"	120"	1"	1 pc	158	4	\$1,217
ARRT42144	42"	144"	1"	2 pcs	166	4	\$1,598
ARRT48144	48"	144"	1"	2 pcs	190	4	\$1,684

**MAVEAST ONLY:** Tops width of 120" are made in 2-piece top, requires 3 bases.  
**MAVWEST:** Tops width of 120" are made in 1-piece top.

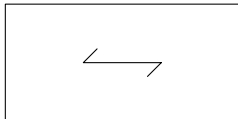

Rectangular Conference Table Top (1" thick top, square corners)

Model#	Depth	Width	Height	Top	Weight	Cube	Price
ARRE3672	36"	72"	1"	1 pc	72	2	\$487
ARRE4284	42"	84"	1"	1 pc	97	2	\$588
ARRE4296	42"	96"	1"	1 pc	111	3	\$672
ARRE42120	42"	120"	1"	1 pc	139	3	\$1,096
ARRE48120	48"	120"	1"	1 pc	158	4	\$1,170
ARRE42144	42"	144"	1"	2 pcs	166	4	\$1,551
ARRE48144	48"	144"	1"	2 pcs	190	4	\$1,639

**MAVEAST ONLY:** Tops width of 120" are made in 2-piece top, requires 3 bases.  
**MAVWEST:** Tops width of 120" are made in 1-piece top.

## Square Table Tops

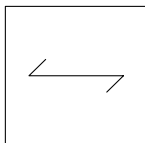

Square Table Table Top (1" thick, square corners)

Model#	Depth	Width	Height	Bases(Required)	Weight	Cube	Price
ARSQ36	36"	36"	1"	1	36	1	\$472
ARSQ42	42"	42"	1"	1	49	1	\$572
ARSQ48	48"	48"	1"	1	64	2	\$722
ARSQ54	54"	54"	1"	1	80	2	\$822

**REMINDER:** Prices are for TOPS ONLY - Order legs/bases separately.

# conference collection

## Apex Series Conference Table Tops

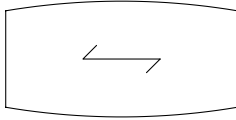

**Boatshape Conference Table Top (1 3/4" thick build up edge, square corners)**

Model#	Depth	Width	Height	Top	Weight	Cube	Price
APBS3672	30"/ 36"	72"	1 3/4"	1 pc	122	3	\$868
APBS4284	36"/ 42"	84"	1 3/4"	1 pc	156	4	\$970
APBS4296	36"/ 42"	96"	1 3/4"	1 pc	176	4	\$1,070
APBS42120	36"/ 42"	120"	1 3/4"	1 pc	214	6	\$1,287
APBS48120	42"/ 48"	120"	1 3/4"	1 pc	237	6	\$1,506
APBS42144	36"/ 42"	144"	1 3/4"	2 pcs	273	7	\$2,009
APBS48144	42"/ 48"	144"	1 3/4"	2 pcs	302	7	\$2,111

**MAVEAST ONLY:** Tops width of 120" are made in 2-piece top, requires 3 bases.  
**MAVWEST:** Tops width of 120" are made in 1-piece top.

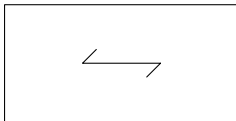

**Rectangular Conference Table Top (1 3/4" thick build up edge, square corners)**

Model#	Depth	Width	Height	Top	Weight	Cube	Price
APRE3672	36"	72"	1 3/4"	1 pc	122	3	\$833
APRE4284	42"	84"	1 3/4"	1 pc	156	4	\$868
APRE4296	42"	96"	1 3/4"	1 pc	176	4	\$1,001
APRE4896	48"	96"	1 3/4"	1 pc	194	5	\$1,379
APRE42120	42"	120"	1 3/4"	1 pc	214	6	\$1,254
APRE48120	48"	120"	1 3/4"	1 pc	237	6	\$1,506
APRE42144	42"	144"	1 3/4"	2 pcs	273	7	\$1,888
APRE48144	48"	144"	1 3/4"	2 pcs	302	7	\$2,029
2⊖ APRE42168	42"	168"	1 3/4"	2 pcs	312	8	\$2,498
2⊖ APRE48168	48"	168"	1 3/4"	2 pcs	345	9	\$2,607
2⊖ APRE42192	42"	192"	1 3/4"	2 pcs	351	9	\$2,677
2⊖ APRE48192	48"	192"	1 3/4"	2 pcs	388	10	\$2,803
2⊖ APRE60120	60"	120"	1 3/4"	2 pcs	282	8	\$1,725
2⊖ APRE60144	60"	144"	1 3/4"	2 pcs	361	9	\$2,682
2⊖ APRE60168	60"	168"	1 3/4"	2 pcs	412	11	\$2,867
2⊖ APRE60192	60"	192"	1 3/4"	2 pcs	462	12	\$3,051

**MAVEAST ONLY:** Tops width of 120" are made in 2-piece top, requires 3 bases.  
**MAVWEST:** Tops width of 120" are made in 1-piece top.  
 Tops \*APRE42168 - \*APRE60192 require 2⊖ LEAD TIME.

# conference collection

## Canyon Series - Conference Table Tops with Grooved Edges and Undertop Trim

(Specify Silver or Black Undertop Trim)

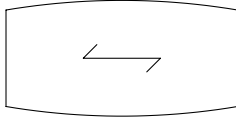

Boatshape Conference Table Top (1" with 3/4" undertop trim, square corners)

Model#	Depth	Width	Height	Top	Weight	Cube	Price
CYBS3672	30" / 36"	72"	1 3/4"	1 pc	125	3	\$1,147
CYBS4284	36" / 42"	84"	1 3/4"	1 pc	169	4	\$1,370
CYBS4296	36" / 42"	96"	1 3/4"	1 pc	193	4	\$1,585
CYBS42120	36" / 42"	120"	1 3/4"	1 pc	242	6	\$1,913
CYBS48120	42" / 48"	120"	1 3/4"	1 pc	276	6	\$2,135

**MAVEAST ONLY:** Tops width of 120" are made in 2-piece top, requires 3 bases.  
**MAVWEST:** Tops width of 120" are made in 1-piece top.

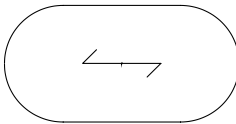

Racetrack Conference Table Top (1" with 3/4" undertop trim)

Model#	Depth	Width	Height	Top	Weight	Cube	Price
CYRT3672	36"	72"	1 3/4"	1 pc	125	3	\$1,243
CYRT4284	42"	84"	1 3/4"	1 pc	169	4	\$1,414
CYRT4296	42"	96"	1 3/4"	1 pc	193	4	\$1,697
CYRT42120	42"	120"	1 3/4"	1 pc	242	6	\$2,083
CYRT48120	48"	120"	1 3/4"	1 pc	276	6	\$2,306

**MAVEAST ONLY:** Tops width of 120" are made in 2-piece top.

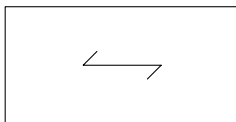

Rectangular Conference Table Top (1" with 3/4" undertop trim, square corners)

Model#	Depth	Width	Height	Top	Weight	Cube	Price
CYRE3672	36"	72"	1 3/4"	1 pc	125	3	\$1,092
CYRE4284	42"	84"	1 3/4"	1 pc	169	4	\$1,323
CYRE4296	42"	96"	1 3/4"	1 pc	193	4	\$1,506
CYRE42120	42"	120"	1 3/4"	1 pc	242	6	\$1,781
CYRE48120	48"	120"	1 3/4"	1 pc	276	6	\$2,043

**MAVEAST ONLY:** Tops width of 120" are made in 2-piece top, requires 3 bases.  
**MAVWEST:** Tops width of 120" are made in 1-piece top.

## Round Table Tops with Grooved Edges and Undertop Trim

(Specify Silver or Black Under Top Trim)

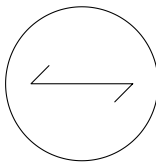

Round Table Table Top (1" with 3/4" undertop trim)

Model#	Depth	Width	Height	Bases(Required)	Weight	Cube	Price
CYRD36	36"	36"	1 3/4"	1	62	2	\$951
CYRD42	42"	42"	1 3/4"	1	85	2	\$1,075
CYRD48	48"	48"	1 3/4"	1	111	3	\$1,174
CYRD54	54"	54"	1 3/4"	1	140	3	\$1,298

**CANYON SERIES TABLE TOP NOTE:** Tops including bases are 29".  
 Standard Maverick power managements are available, see page 154-155.  
 (Cut-out for power management is included)

**REMINDER:** Prices are for TOPS ONLY - Order legs/bases separately.

# conference collection

## Bases for Conference Table Tops

**NOTE:** Stretcher bars are std., when conference table top and sq. panel legs, are purchased together. (Legs and stretcher bars are not design to accept power units)



### Square Panel Leg, 1" Thick

Model#	Depth	Width	Height	Top Depth	Weight	Cube	Price
ARLEGA20	1"	20"	28"	36"	27	1	\$77/ea.
ARLEGA24	1"	24"	28"	42" & 48"	33	1	\$77/ea.
ARLEG A30	1"	30"	28"	54" & 60"	41	1	\$236/ea.

**Use for Arroyo Conference Table Tops only. (AR legs do not support all other series table tops)**  
**Stretcher bars 1"x7"H are standard (MM stretcher). Must order top and bases together.**  
**Add MMCUT1...\$114 for each leg when ordering power management for base cutout.**  
**NOTE: MMStretcher \$67 each, must specify table top model#.**



### Square Panel Leg, 1 3/4" Thick

Model#	Depth	Width	Height	Top Depth	Weight	Cube	Price
MMLEGA20	1 3/4"	20"	28"	36"	27	1	\$169/ea.
MMLEGA24	1 3/4"	24"	28"	42" & 48"	33	1	\$169/ea.
MMLEGA30	1 3/4"	30"	28"	54" & 60"	41	1	\$236/ea.

**Stretcher bars 1"x7"H are standard (MMstretcher). Must order top and bases together.**  
**Add MMCUT1...\$114 for each leg when ordering power management for base cutout.**  
**NOTE: MMStretcher \$67 each, must specify table top model#.**

## Base Placement

### Bases Required & Base Placement for Square Panel Legs 1" Thick (Arroyo series tops only)

Tops	Table Depth	Table Width	Center of 1st Base	Center of 2nd Base	Center of 3rd Base	Center of 4th Base	Center of 5th Base
1 pc	36"	72"	20 1/2"	51 1/2"			
1 pc	42"	84"	20 1/2"	63 1/2"			
1 pc	42"	96"	20 1/2"	75 1/2"			
1 pc	48"	96"	20 1/2"	75 1/2"			
1 pc	42"	120"	20 1/2"	60"	99 1/2"		
1 pc	48"	120"	20 1/2"	60"	99 1/2"		
2 pcs	42"	144"	20 1/2"	72"	123 1/2"		
2 pcs	48"	144"	20 1/2"	72"	123 1/2"		

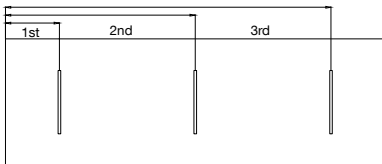

### Bases Required & Base Placement for Square Panel Legs 1 3/4" Thick (All series)

Tops	Table Depth	Table Width	Center of 1st Base	Center of 2nd Base	Center of 3rd Base	Center of 4th Base	Center of 5th Base
1 pc	36"	72"	20 7/8"	51 1/8"			
1 pc	42"	84"	20 7/8"	63 1/8"			
1 pc	42"	96"	20 7/8"	75 1/8"			
1 pc	48"	96"	20 7/8"	75 1/8"			
1 pc	42"	120"	20 7/8"	60"	99 1/8"		
1 pc	48"	120"	20 7/8"	60"	99 1/8"		
2 pcs	42"	144"	20 7/8"	72"	123 1/8"		
2 pcs	48"	144"	20 7/8"	72"	123 1/8"		
2 pcs	42"	168"	20 7/8"	52 7/16"	84"	115 9/16"	147 1/8"
2 pcs	48"	168"	20 7/8"	52 7/16"	84"	115 9/16"	147 1/8"
2 pcs	42"	192"	20 7/8"	58 7/16"	96"	133 9/16"	171 1/8"
2 pcs	48"	192"	20 7/8"	58 7/16"	96"	133 9/16"	171 1/8"
2 pcs	60"	120"	20 7/8"	60"	99 1/8"		
2 pcs	60"	144"	20 7/8"	72"	123 1/8"		
2 pcs	60"	168"	20 7/8"	52 7/16"	84"	115 9/16"	147 1/8"
2 pcs	60"	192"	20 7/8"	58 7/16"	96"	133 9/16"	171 1/8"

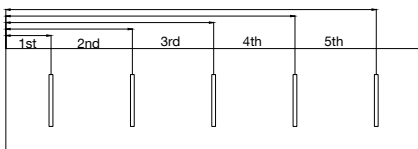



# conference collection

## Bases for Conference Table Tops

**NOTE:** Stretcher bars are standard with conference table top and radius panel legs.  
(Legs and stretcher bars are not design to accept power units)

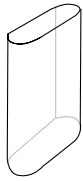

### Radius Panel Leg (Made in HPL material only)

Model#	Depth	Width	Height	Top Depth	Weight	Cube	Price
MMLEGB20	2 3/8"	20"	28"	36"	31	1	\$302/ea.
MMLEGB24	2 3/8"	24"	28"	42" & 48"	37	1	\$302/ea.
MMLEGB30	2 3/8"	30"	28"	54" & 60"	46	2	\$485/ea.

**Stretcher bars 1"x7"H are standard (MMstretcher). Must order top and bases together.**  
Add MMCUT1...\$114 for each leg when ordering power management for base cutout.  
Grain runs horizontal. Limited HPL colors, see color chart for color availability.  
**NOTE: MMStretcher \$67 each, must specify table top model#.**

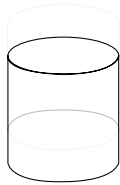

### Cylinder Base (Made in HPL material only)

Model#	Depth	Width	Height	Top Depth	Weight	Cube	Price
MMLEGC20	20"	20"	28"	36"	60	7	\$605/ea.
MMLEGC24	24"	24"	28"	42" & 48"	70	10	\$701/ea.
MMLEGC30	30"	30"	28"	54" & 60"	80	15	\$816/ea.

**If ordering Maverick standard power units, add MMCUT2...\$179 (top and bottom cut-out is required).**  
Limited HPL colors, see color chart for color availability.

## Base Placement

### Bases Required & Base Placement for Radius Panel Legs 2 3/8" Thick (All series)

Tops	Table Depth	Table Width	Center of 1st Base	Center of 2nd Base	Center of 3rd Base	Center of 4th Base	Center of 5th Base
1 pc	36"	72"	21 3/16"	50 13/16"			
1 pc	42"	84"	21 3/16"	62 13/16"			
1 pc	42"	96"	21 3/16"	74 13/16"			
1 pc	48"	96"	21 3/16"	75 1/8"			
1 pc	42"	120"	21 3/16"	60"	98 13/16"		
1 pc	48"	120"	21 3/16"	60"	99 1/8"		
2 pcs	42"	144"	21 3/16"	72"	122 13/16"		
2 pcs	48"	144"	21 3/16"	72"	123 1/8"		
2 pcs	42"	168"	21 3/16"	52 19/32"	84"	115 13/32"	146 13/16"
2 pcs	48"	168"	21 3/16"	52 19/32"	84"	115 13/32"	146 13/16"
2 pcs	42"	192"	21 3/16"	58 19/32"	96"	133 13/32"	170 13/16"
2 pcs	48"	192"	21 3/16"	58 19/32"	96"	133 13/32"	170 13/16"
2 pcs	60"	120"	21 3/16"	60"	99 1/8"		
2 pcs	60"	144"	21 3/16"	72"	123 1/8"		
2 pcs	60"	168"	21 3/16"	52 19/32"	84"	115 13/32"	146 13/16"
2 pcs	60"	192"	21 3/16"	58 19/32"	96"	133 13/32"	170 13/16"

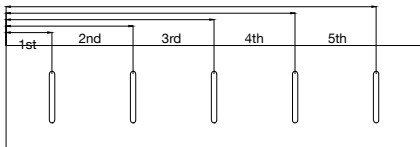

### Bases Required & Base Placement for Cylinder Bases (All series)

Tops	Table Depth	Table Width	Center of 1st Base	Center of 2nd Base	Center of 3rd Base	Center of 4th Base	Center of 5th Base
1 pc	36"	72"	25"	47"			
1 pc	42"	84"	27"	57"			
1 pc	42"	96"	27"	69"			
1 pc	48"	96"	27"	69"			
1 pc	42"	120"	27"	93"			
1 pc	48"	120"	27"	93"			
2 pcs	42"	144"	27"	72"	117"		
2 pcs	48"	144"	27"	72"	117"		
2 pcs	42"	168"	27"	84"	141"		
2 pcs	48"	168"	27"	84"	141"		
2 pcs	42"	192"	27"	96"	165"		
2 pcs	48"	192"	27"	96"	165"		
2 pcs	60"	120"	30"	90"			
2 pcs	60"	144"	30"	72"	114"		
2 pcs	60"	168"	30"	84"	138"		
2 pcs	60"	192"	30"	96"	162"		

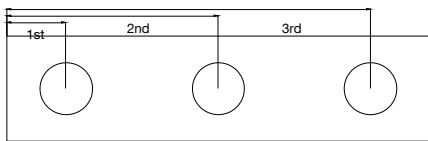

# conference collection

## Bases for Conference Table Tops



### Half-Cylinder Base (Made in HPL material only)

Model#	Depth	Width	Height	Top Depth	Weight	Cube	Price
MMLEGD20	10	20"	28"	36"	30	4	\$551/ea.
MMLEGD24	12"	24"	28"	42" & 48"	35	5	\$648/ea.
MMLEGD30	15"	30"	28"	54" & 60"	40	8	\$763/ea.

**Not design to accept power units.**  
**If ordering Maverick standard power unit, add MMCUT2 \$179 (Top and bottom cutout)**  
**Limited HPL colors, see color chart for color availability.**

## Base Placement

### Bases Required & Base Placement for Half-Cylinder Bases (All series)

Tops	Table Depth	Table Width	Center of 1st Base	Center of 2nd Base	Center of 3rd Base	Center of 4th Base	Center of 5th Base
1 pc	36"	72"	20 1/2"	51 1/2"			
1 pc	42"	84"	26"	58"			
1 pc	42"	96"	26"	70"			
1 pc	48"	96"	26"	69"			
1 pc	42"	120"	26"	94"			
1 pc	48"	120"	26"	94"			
2 pcs	42"	144"	26"	72"	118"		
2 pcs	48"	144"	26"	72"	118"		
2 pcs	42"	168"	26"	84"	142"		
2 pcs	48"	168"	26"	84"	142"		
2 pcs	42"	192"	26"	96"	166"		
2 pcs	48"	192"	26"	96"	166"		
2 pcs	60"	120"	27 1/2"	92 1/2"			
2 pcs	60"	144"	27 1/2"	72"	116 1/2"		
2 pcs	60"	168"	27 1/2"	84"	140 1/2"		
2 pcs	60"	192"	27 1/2"	96"	164 1/2"		

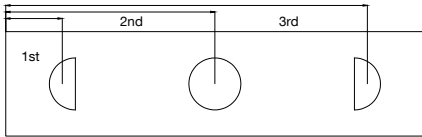

## Power Bases, for Power Management Wire Access

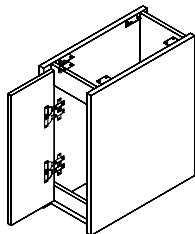

### Square Panel Base with End Access Door

Model#	Depth	Width	Height	Top Depth	Weight	Cube	Price
MMLEGM1320WD	13"	20"	28"	36"	47	5	\$459
MMLEGM1324WD	13"	24"	28"	42" & 48"	53	5	\$485
MMLEGM1330WD	13"	30"	28"	54" & 60"	62	7	\$606

**Leg Notes: Top and Bottom open (no top). Grommets are standard only when ordered with wire trough. No plinth base.**

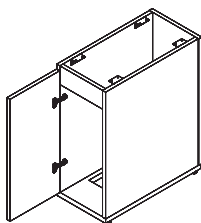

### Square Panel Base with End Access Door and Plinth Base

Model#	Depth	Width	Height	Top Depth	Weight	Cube	Price
MMLEGMP1320WD	13"	20"	28"	36"	54	5	\$802
MMLEGMP1324WD	13"	24"	28"	42" & 48"	62	5	\$824
MMLEGMP1330WD	13"	30"	28"	54" & 60"	73	7	\$859

**Leg Notes: No top, bottom cut out 11"x8 1/2". Grommets are standard only when ordered with wire trough. Plinth base color will match base. For silver color plinth base, must be specified on order (no upcharge).**

### NOTES:

- For wire management trough and base placement, see p. 145.
- Power bases: cutout is required when placing 11"W or wider power management over bases, add MMCUT3 \$179 each base.

## Wire Management for Power Bases

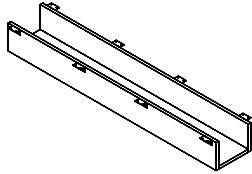

Wire Management Trough (with bottom cut out)

Model#	Depth	Width	Height	Weight	Cube	Price
MMWMT	11"	varies	7"	31	3	\$203

Notes: Dimensions are based on conference table top sizes. Can be use with power bases or panel legs. (2) bases requires (1) trough. (3) bases requires (2) troughs. Wire access bottom cut out 3"D. Width varies.

## Base Placement for Power Bases

Bases Required & Base Placement for 13"D Power Bases (All series)

Tops	Table Depth	Table Width	Center of 1st Base	Center of 2nd Base	Center of 3rd Base	Center of 4th Base	Center of 5th Base
1 pc	36"	72"	21"	51"			
1 pc	42"	84"	21"	63"			
1 pc	42"	96"	26"	70"			
1 pc	48"	96"	26"	70"			
1 pc	42"	120"	26"	94"			
1 pc	48"	120"	26"	94"			
2 pcs	42"	144"	26"	72"	118"		
2 pcs	48"	144"	26"	72"	118"		
2 pcs	42"	168"	26"	84"	142"		
2 pcs	48"	168"	26"	84"	142"		
2 pcs	42"	192"	26"	96"	166"		
2 pcs	48"	192"	26"	96"	166"		
2 pcs	60"	120"	26"	94"			
2 pcs	60"	144"	26"	72"	118"		
2 pcs	60"	168"	26"	84"	142"		
2 pcs	60"	192"	26"	96"	166"		

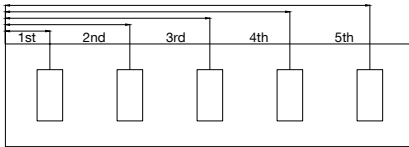

## Apex Metal Legs for Conference Table Tops

(All Series)

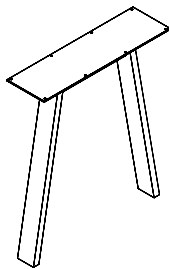

A-Frame Leg

Model#	Depth	Width	Height	Color	Top Depth	Weight	Cube	Price
APLEGA20B	20"	6"	28"	Black	36"	26	3	\$470
APLEGA20S	20"	6"	28"	Silver	36"	26	3	\$470
APLEGA20W	20"	6"	28"	White	36"	26	3	\$470
APLEGA24B	24"	6"	28"	Black	42" & 48"	32	4	\$514
APLEGA24S	24"	6"	28"	Silver	42" & 48"	32	4	\$514
APLEGA24W	24"	6"	28"	White	42" & 48"	32	4	\$514
APLEGA30B	30"	6"	28"	Black	54" & 60"	36	5	\$553
APLEGA30S	30"	6"	28"	Silver	54" & 60"	36	5	\$553
APLEGA30W	30"	6"	28"	White	54" & 60"	36	5	\$553

For bases required and base placement see p. 146

# conference collection

## Apex Metal Legs for Conference Table Tops

(All Series)

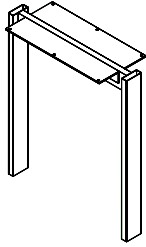

### Shared Double Post Leg

Model#	Depth	Width	Height	Color	Top Depth	Weight	Cube	Price
APDPML20B	20"	9"	28"	Black	36"	26	3	\$420
APDPML20S	20"	9"	28"	Silver	36"	26	3	\$420
APDPML20W	20"	9"	28"	White	36"	26	3	\$420
APDPML24B	24"	9"	28"	Black	42" & 48"	32	4	\$464
APDPML24S	24"	9"	28"	Silver	42" & 48"	32	4	\$464
APDPML24W	24"	9"	28"	White	42" & 48"	32	4	\$464
APDPML30B	30"	9"	28"	Black	54" & 60"	36	5	\$504
APDPML30S	30"	9"	28"	Silver	54" & 60"	36	5	\$504
APDPML30W	30"	9"	28"	White	54" & 60"	36	5	\$504

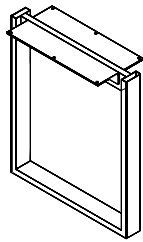

### Shared D-Leg

Model#	Depth	Width	Height	Color	Top Depth	Weight	Cube	Price
APMDL20B	20"	9"	28"	Black	36"	28	3	\$524
APMDL20S	20"	9"	28"	Silver	36"	28	3	\$524
APMDL20W	20"	9"	28"	White	36"	28	3	\$524
APMDL24B	24"	9"	28"	Black	42" & 48"	37	4	\$544
APMDL24S	24"	9"	28"	Silver	42" & 48"	37	4	\$544
APMDL24W	24"	9"	28"	White	42" & 48"	37	4	\$544
APMDL30B	30"	9"	28"	Black	54" & 60"	40	5	\$582
APMDL30S	30"	9"	28"	Silver	54" & 60"	40	5	\$582
APMDL30W	30"	9"	28"	White	54" & 60"	40	5	\$582

## Wire Management

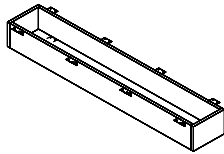

### Wire Management Trough Box (with bottom cut out)

Model#	Depth	Width	Height	Weight	Cube	Price
APWMT	11"	Varies	7"	34	3	\$417

APWMT use with Apex metal legs only. Dimensions are based on conference table sizes.  
Troughs: 2-legs requires 1, 3-legs requires 2, 4-legs requires 3, 5-legs requires 4.  
Wire access bottom cut out 3"D. Width varies.

## Base Placement

### Legs Required & Leg Placement for Apex Metal Legs

Tops	Table Depth	Table Width	Center of 1st Base	Center of 2nd Base	Center of 3rd Base	Center of 4th Base	Center of 5th Base
1 pc	36"	72"	20 7/8"	51 1/8"			
1 pc	42"	84"	20 7/8"	63 1/8"			
1 pc	42"	96"	20 7/8"	75 1/8"			
1 pc	48"	96"	20 7/8"	75 1/8"			
1 pc	42"	120"	20 7/8"	60"	98 13/16"		
1 pc	48"	120"	20 7/8"	60"	99 1/8"		
2 pcs	42"	144"	20 7/8"	72"	122 13/16"		
2 pcs	48"	144"	20 7/8"	72"	123 1/8"		
2 pcs	42"	168"	20 7/8"	52 7/16"	84"	115 9/16"	147 1/8"
2 pcs	48"	168"	20 7/8"	52 7/16"	84"	115 9/16"	147 1/8"
2 pcs	42"	192"	20 7/8"	52 7/16"	96"	133 9/16"	171 1/8"
2 pcs	48"	192"	20 7/8"	58 7/16"	96"	133 9/16"	171 1/8"
2 pcs	60"	120"	20 7/8"	60"	99 1/8"		
2 pcs	60"	144"	20 7/8"	72"	123 1/8"		
2 pcs	60"	168"	20 7/8"	52 7/16"	84"	115 9/16"	147 1/8"
2 pcs	60"	192"	20 7/8"	58 7/16"	96"	133 9/16"	171 1/8"

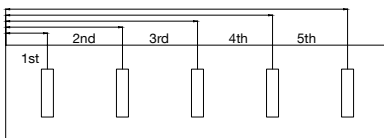

# conference collection

## Bases, for Round and Square Table Tops

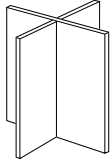

### Flat Panel X-Base

Model#	Depth	Width	Height	Top Depth	Weight	Cube	Price
MMLEGF20	20"	20"	28"	36"	31	7	\$269
MMLEGF24	24"	24"	28"	42" & 48"	37	10	\$302
MMLEGF30	24"	30"	28"	54" & 60"	46	15	\$371



### Sculptured Panel X-Base

Model#	Depth	Width	Height	Top Depth	Weight	Cube	Price
MMLEGG20	20"	20"	28"	36"	31	7	\$347
MMLEGG24	24"	24"	28"	42" & 48"	37	10	\$381

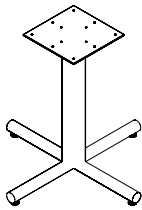

### Four-Star Metal Base

Model#	Depth	Width	Height	Top Depth	Color	Weight	Cube	Price
MMLEGI30B	30"	30"	28"	36"	Black	19	17	\$540
MMLEGI36B	36"	36"	28"	42", 48" & 54"	Black	30	24	\$587
MMLEGI30S	30"	30"	28"	36"	Silver Powdercoat	19	17	\$540
MMLEGI36S	36"	36"	28"	42", 48" & 54"	Silver Powdercoat	30	24	\$587
MMLEGI30C	30"	30"	28"	36"	Chrome	19	17	\$715
MMLEGI36C	36"	36"	28"	42", 48" & 54"	Chrome	30	24	\$769

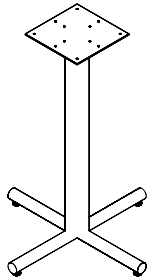

### Bar Height Metal Four Star Base

Model#	Depth	Width	Height	Top Depth	Color	Weight	Cube	Price
MMLEGIBH30B	30"	30"	41"	36"	Black	24	25	\$641
MMLEGIBH36B	36"	36"	41"	42", 48" & 54"	Black	35	35	\$688
MMLEGIBH30S	30"	30"	41"	36"	Silver Powdercoat	24	25	\$641
MMLEGIBH36S	36"	36"	41"	42", 48" & 54"	Silver Powdercoat	35	35	\$688
MMLEGIBH30C	30"	30"	41"	36"	Chrome	24	25	\$814
MMLEGIBH36C	36"	36"	41"	42", 48" & 54"	Chrome	35	35	\$875

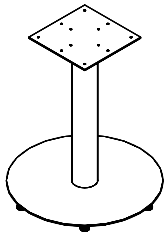

### Round Disc Metal Base

Model#	Depth	Width	Height	Top Depth	Color	Weight	Cube	Price
MMLEGR24B	24"	4"	27 3/4"	36", 42" & 48"	Black	45	10	\$1,080
MMLEGR28B	28"	4"	27 3/4"	54"	Black	50	13	\$1,238
MMLEGR24S	24"	4"	27 3/4"	36", 42" & 48"	Silver Powdercoat	45	10	\$1,080
MMLEGR28S	28"	4"	27 3/4"	54"	Silver Powdercoat	50	13	\$1,238
MMLEGR24C	24"	4"	27 3/4"	36", 42" & 48"	Chrome	45	10	\$1,294
MMLEGR28C	28"	4"	27 3/4"	54"	Chrome	50	13	\$1,618

Leg Notes: Fixed mounting plate 12" x 12"

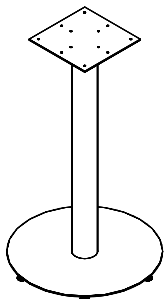

### Round Disc Metal Base, Bar Height

Model#	Depth	Width	Height	Top Depth	Color	Weight	Cube	Price
MMLEGRBH24B	24"	4"	40 3/4"	36" & 42"	Black	50	14	\$1,178
MMLEGRBH28B	28"	4"	40 3/4"	48"D	Black	55	19	\$1,354
MMLEGRBH24S	24"	4"	40 3/4"	36" & 42"	Silver Powdercoat	50	14	\$1,178
MMLEGRBH28S	28"	4"	40 3/4"	48"D	Silver Powdercoat	55	19	\$1,354
MMLEGRBH24C	24"	4"	40 3/4"	36" & 42"	Chrome	50	14	\$1,505
MMLEGRBH28C	28"	4"	40 3/4"	48"	Chrome	55	19	\$1,708

Leg Notes: Fixed mounting plate 12" x 12"

# conference collection

## Bases, for Round and Square Table Tops

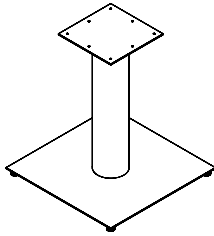

### Square Metal Base

Model#	Depth	Width	Height	Top Depth	Color	Weight	Cube	Price
MMLEGS20B	20"	4"	27 3/4"	36"	Black	45	10	\$1,080
MMLEGS20S	20"	4"	27 3/4"	36"	Silver	45	10	\$1,080
MMLEGS30B	30"	6"	27 3/4"	42" & 48"	Black	50	13	\$1,238
MMLEGS30S	30"	6"	27 3/4"	42" & 48"	Silver	50	13	\$1,238

**Leg Notes:** Fixed mounting plate 12" x 12"

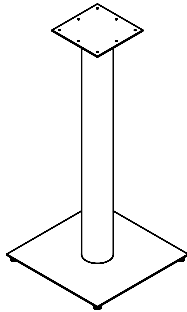

### Square Metal Base, Bar Height

Model#	Depth	Width	Height	Top Depth	Color	Weight	Cube	Price
MMLEGSBH20B	20"	4"	40 3/4"	36"	Black	50	14	\$1,178
MMLEGSBH20S	20"	4"	40 3/4"	36"	Silver	50	14	\$1,178
MMLEGSBH30B	30"	6"	40 3/4"	42" & 48"	Black	55	19	\$1,354
MMLEGSBH30S	30"	6"	40 3/4"	42" & 48"	Silver	55	19	\$1,354

**Leg Notes:** Fixed mounting plate 12" x 12"

## Community Tables - Maverick Series

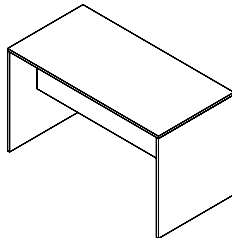

### Community Table (1" top & end panels, 2-half modesty panels)

Model#	Depth	Width	Height	Weight	Cube	Price
MMNCTA3672	36"	72"	42"	200	63	\$1,290
MMNCTA3684	36"	84"	42"	220	74	\$1,379
MMNCTA3696	36"	96"	42"	241	84	\$1,466
MMNCTA4272	42"	72"	42"	224	74	\$1,390
MMNCTA4284	42"	84"	42"	246	86	\$1,487
MMNCTA4296	42"	96"	42"	269	98	\$1,583

**Optional HPL Modesty upgrade...**For 72"W add MMUMOD72 \$478. For 84"W add MMUMOD84 \$568. For 96"W add MMUMOD96 \$650. 84"W & 96"W tables ship disassembled.

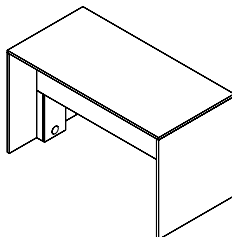

### Community Table (1" top & end panels, 2-half modesty panels, 2-troughs with grommets)

Model#	Depth	Width	Height	Weight	Cube	Price
MMNCTAP3672	36"	72"	42"	220	63	\$1,636
MMNCTAP3684	36"	84"	42"	240	74	\$1,723
MMNCTAP3696	36"	96"	42"	261	84	\$1,810
MMNCTAP4272	42"	72"	42"	244	74	\$1,736
MMNCTAP4284	42"	84"	42"	266	86	\$1,832
MMNCTAP4296	42"	96"	42"	289	98	\$1,925

**Optional HPL Modesty upgrade...**For 72"W add MMUMOD72 \$478. For 84"W add MMUMOD84 \$568. For 96"W add MMUMOD96 \$650. 84"W & 96"W tables ship disassembled.

**NOTE:** For HPL Modesty color upgrade options, see p. 151.

# conference collection

## Community Tables - Maverick Series

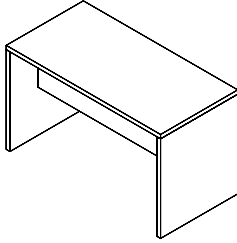

Community Table (1 3/4" top & end panels, 2-half modesty panels)

Model#	Depth	Width	Height	Weight	Cube	Price
MMNCTB3672	36"	72"	42"	315	63	\$1,668
MMNCTB3684	36"	84"	42"	343	74	\$1,795
MMNCTB3696	36"	96"	42"	373	84	\$1,922
MMNCTB4272	42"	72"	42"	357	74	\$1,822
MMNCTB4284	42"	84"	42"	390	86	\$1,962
MMNCTB4296	42"	96"	42"	423	98	\$2,104

Optional HPL Modesty upgrade...For 72"W add MMUMOD72...\$478. For 84"W add MMUMOD84 \$568. For 96"W add MMUMOD96 \$650. 84"W & 96"W tables ship disassembled.

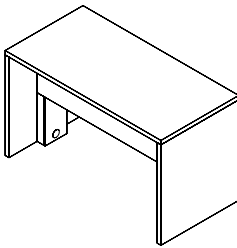

Community Table (1 3/4" top & end panels, 2-half modesty panels, 2-troughs with grommets)

Model#	Depth	Width	Height	Weight	Cube	Price
MMNCTBP3672	36"	72"	42"	335	63	\$2,013
MMNCTBP3684	36"	84"	42"	363	74	\$2,140
MMNCTBP3696	36"	96"	42"	393	84	\$2,268
MMNCTBP4272	42"	72"	42"	377	74	\$2,166
MMNCTBP4284	42"	84"	42"	410	86	\$2,308
MMNCTBP4296	42"	96"	42"	443	98	\$2,449

Optional HPL Modesty upgrade...For 72"W add MMUMOD72 \$478. For 84"W add MMUMOD84 \$568. For 96"W add MMUMOD96 \$650. 84"W & 96"W tables ship disassembled.

## Community Tables - Canyon Series

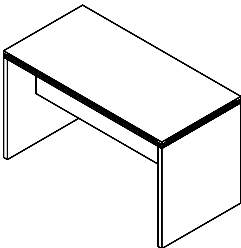

Community Table (1" thick grooved edge top, 3/4" silver undertrim, 3/4" under top, 1 3/4" end panels, 2-half modesty panels)

Model#	Depth	Width	Height	Weight	Cube	Price
CYNCTB3672	36"	72"	42"	368	63	\$2,099
CYNCTB3684	36"	84"	42"	405	74	\$2,266
CYNCTB3696	36"	96"	42"	444	84	\$2,433
CYNCTB4272	42"	72"	42"	419	74	\$2,292
CYNCTB4284	42"	84"	42"	469	86	\$2,476
CYNCTB4296	42"	96"	42"	506	98	\$2,663

Optional HPL Modesty upgrade...For 72"W add MMUMOD72 \$478. For 84"W add MMUMOD84 \$568. For 96"W add MMUMOD96 \$650. 84"W & 96"W tables ship disassembled.

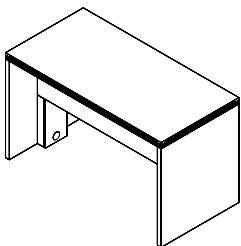

Community Table (1" thick grooved edge top, 3/4" silver undertrim, 3/4" under top, 1 3/4" end panels, 2-half modesty panels, 2 troughs with grommet)

Model#	Depth	Width	Height	Weight	Cube	Price
CYNCTBP3672	36"	72"	42"	388	63	\$2,444
CYNCTBP3684	36"	84"	42"	425	74	\$2,611
CYNCTBP3696	36"	96"	42"	464	84	\$2,776
CYNCTBP4272	42"	72"	42"	439	74	\$2,636
CYNCTBP4284	42"	84"	42"	489	86	\$2,821
CYNCTBP4296	42"	96"	42"	526	98	\$3,006

Optional HPL Modesty upgrade...For 72"W add MMUMOD72...\$478. For 84"W add MMUMOD84 \$568. For 96"W add MMUMOD96 \$650. 84"W & 96"W tables ship disassembled.

**NOTE:** For HPL Modesty color upgrade options, see p. 151.

# conference collection

## Community Media Tables - Maverick Series

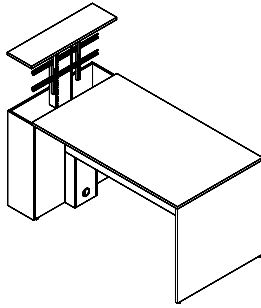

### Community Media Table Box and Trough, Full End Panel

Model#	Depth	Width	Height	Max TV	Weight	Cube	Price
MMNCTATV4272FP	42"	72"	42"	38"W	354	74	\$6,051
MMNCTATV4284FP	42"	84"	42"	38"W	377	86	\$6,138
MMNCTATV4296FP	42"	96"	42"	38"W	400	98	\$6,223
MMNCTATV4872FP	48"	72"	42"	44"W	386	84	\$6,168
MMNCTATV4884FP	48"	84"	42"	44"W	411	98	\$6,261
MMNCTATV4896FP	48"	96"	42"	44"W	436	112	\$6,354

Includes TV lift mechanism. Optional HPL Modesty color upgrade: For 72"W add MMUMOD72 \$478, for 84"W add MMUMOD84 \$568, for 96"W add MMUMOD96 \$650. All tables ship disassembled.

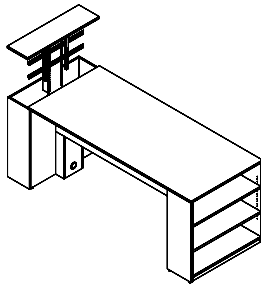

### Community Media Table Box and Trough, 14"D Bookcase

Model#	Depth	Width	Height	Adj. Sh	Max TV	Weight	Cube	Price
MMNCTATV4272BC	42"	72"	42"	2	38"W	378	74	\$6,649
MMNCTATV4284BC	42"	84"	42"	2	38"W	401	86	\$6,739
MMNCTATV4296BC	42"	96"	42"	2	38"W	424	98	\$6,824
MMNCTATV4872BC	48"	72"	42"	4	44"W	423	84	\$6,829
MMNCTATV4884BC	48"	84"	42"	4	44"W	448	98	\$6,922
MMNCTATV4896BC	48"	96"	42"	4	44"W	473	112	\$7,015

Includes TV lift mechanism. 48"D Bookcase has a center divider. Adjustable Shelves are 3/4" thick. Optional HPL Modesty color upgrade: For 72"W add MMUMOD72 \$478, for 84"W add MMUMOD84 \$568, for 96"W add MMUMOD96 \$650. All tables ship disassembled.

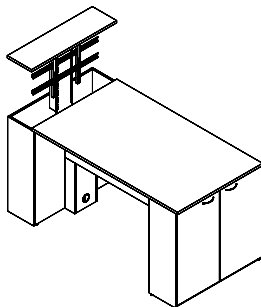

### Community Media Table Box and Trough, 14"D Hinged Door Cabinet (H3B Handles)

Model#	Depth	Width	Height	Adj. Sh	Max TV	Weight	Cube	Price
MMNCTATV4272HD	42"	72"	42"	2	38"W	393	74	\$7,059
MMNCTATV4284HD	42"	84"	42"	2	38"W	416	86	\$7,146
MMNCTATV4296HD	42"	96"	42"	2	38"W	439	98	\$7,232
MMNCTATV4872HD	48"	72"	42"	4	44"W	437	84	\$7,317
MMNCTATV4884HD	48"	84"	42"	4	44"W	462	98	\$7,411
MMNCTATV4896HD	48"	96"	42"	4	44"W	487	112	\$7,504

Includes TV lift mechanism. 48"D Cabinet has 4-doors. Adjustable Shelves are 3/4" thick. Optional HPL Modesty color upgrade: for 72"W add MMUMOD72 \$478, for 84"W add MMUMOD84 \$568, for 96"W add MMUMOD96 \$650. Upgrade to MMH3S Handles n/c. All tables ship disassembled.

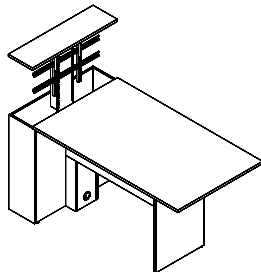

### Community Media Table, Box and Trough, Half Panel Leg

Model#	Depth	Width	Height	Max TV	Weight	Cube	Price
MMNCTATV4272HP	42"	72"	42"	38"W	318	74	\$5,917
MMNCTATV4284HP	42"	84"	42"	38"W	341	86	\$6,003
MMNCTATV4296HP	42"	96"	42"	38"W	364	98	\$6,089
MMNCTATV4872HP	48"	72"	42"	44"W	343	84	\$6,011
MMNCTATV4884HP	48"	84"	42"	44"W	368	98	\$6,104
MMNCTATV4896HP	48"	96"	42"	44"W	393	112	\$6,194

Includes TV lift mechanism. Optional HPL Modesty color upgrade: for 72"W add MMUMOD72 \$478, for 84"W add MMUMOD84 \$568, For 96"W add MMUMOD96 \$650. All tables ship disassembled.

**NOTE:** For HPL Modesty color upgrade options, see p. 151.



# conference collection

## HPL Modesty Panel Color Upgrade Options (For Community Tables & Media Tables)



Silver



Ruby



Tangerine



Pacific Ocean



Starry Night



Leaf



Seafoam



Lilac

**NOTE:**

For color HPL modesty panel options, see p. 209.

For power units, see pp. 154-155 (center cut out top is standard. Cut outs are included).



# conference collection

## Square Cube Tables

(Standard open bottom)

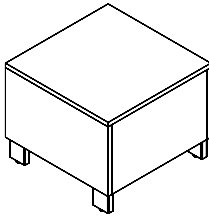

### Square Cube Tables with Apex Silver Feet (TFM)

Model#	Depth	Width	Height	Weight	Cube	Price
MMSCAP202016	20"	20"	16"	49	4	\$674
MMSCAP202020	20"	20"	20"	55	5	\$674
MMSCAP242416	24"	24"	16"	60	6	\$812
MMSCAP242420	24"	24"	20"	68	7	\$812
MMSCAP243016	24"	30"	16"	70	7	\$921
MMSCAP243616	24"	36"	16"	80	8	\$1,027
MMSCAP244816	24"	48"	16"	100	11	\$1,248

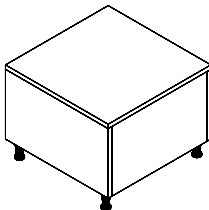

### Square Cube Tables with Napa Feet (TFM)

Model#	Depth	Width	Height	Weight	Cube	Price
MMSCNA202016	20"	20"	16"	49	4	\$674
MMSCNA202020	20"	20"	20"	55	5	\$674
MMSCNA242416	24"	24"	16"	60	6	\$812
MMSCNA242420	24"	24"	20"	68	7	\$812
MMSCNA243016	24"	30"	16"	70	7	\$921
MMSCNA243616	24"	36"	16"	80	8	\$1,027
MMSCNA244816	24"	48"	16"	100	11	\$1,248

Feet color available in brushed nickel only.

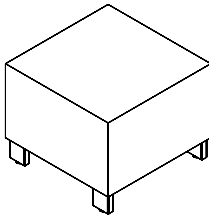

### Square Cube Tables with Apex Silver Feet (HPL)

Model#	Depth	Width	Height	Weight	Cube	Price
MMSCAPHP202016	20"	20"	16"	49	4	\$825
MMSCAPHP202020	20"	20"	20"	55	5	\$825
MMSCAPHP242416	24"	24"	16"	60	6	\$1,001
MMSCAPHP242420	24"	24"	20"	68	7	\$1,001
MMSCAPHP243016	24"	30"	16"	70	7	\$1,140
MMSCAPHP243616	24"	36"	16"	80	8	\$1,285
MMSCAPHP244816	24"	48"	16"	100	11	\$1,568

HPL requires 20 LEADTIME. Limited HPL colors, see color chart for color availability.

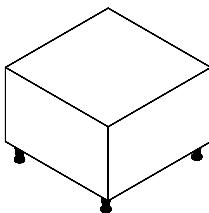

### Square Cube Tables with Napa Feet (HPL)

Model#	Depth	Width	Height	Weight	Cube	Price
MMSCNAHP202016	20"	20"	16"	49	4	\$825
MMSCNAHP202020	20"	20"	20"	55	5	\$825
MMSCNAHP242416	24"	24"	16"	60	6	\$1,001
MMSCNAHP242420	24"	24"	20"	68	7	\$1,001
MMSCNAHP243016	24"	30"	16"	70	7	\$1,140
MMSCNAHP243616	24"	36"	16"	80	8	\$1,285
MMSCNAHP244816	24"	48"	16"	100	11	\$1,568

HPL requires 20 LEADTIME. Feet color available in brushed nickel only. Limited HPL colors, see color chart for color availability.

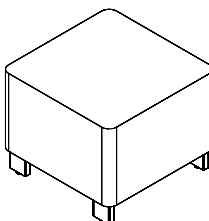

### Radius Cube Tables with Apex Silver Feet (HPL)

Model#	Depth	Width	Height	Weight	Cube	Price
MMRCAPHP202016	20"	20"	16"	49	4	\$970
MMRCAPHP202020	20"	20"	20"	55	5	\$970
MMRCAPHP242416	24"	24"	16"	60	6	\$1,191
MMRCAPHP242420	24"	24"	20"	68	7	\$1,191
MMRCAPHP243016	24"	30"	16"	70	7	\$1,368
MMRCAPHP243616	24"	36"	16"	80	8	\$1,542
MMRCAPHP244816	24"	48"	16"	100	11	\$1,884

HPL requires 20 LEADTIME. Limited HPL colors, see color chart for color availability.

# conference collection

## Square Cube Tables

(Standard open bottom)

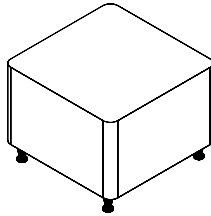

### Radius Cube Tables with Napa Feet (HPL)

Model#	Depth	Width	Height	Weight	Cube	Price
MMRCNAHP202016	20"	20"	16"	49	4	\$970
MMRCNAHP202020	20"	20"	20"	55	5	\$970
MMRCNAHP242416	24"	24"	16"	60	6	\$1,191
MMRCNAHP242420	24"	24"	20"	68	7	\$1,191
MMRCNAHP243016	24"	30"	16"	70	7	\$1,368
MMRCNAHP243616	24"	36"	16"	80	8	\$1,542
MMRCNAHP244816	24"	48"	16"	100	11	\$1,884

HPL requires 20 LEADTIME. Feet color available in brushed nickle only. Limited HPL colors, see color chart for color availability.

## Data/Power Management

(Square Cube Tables)



### Rectangular Power Grommet (1-Power, 2-Power USB with adapter, 108" cord)

Model#	Depth	Width	Height	Weight	Cube	Color	Price
APRPG1B	2 1/4"	3 3/4"	3"	2	1	Black	\$448
APRPG1S	2 1/4"	3 3/4"	3"	2	1	Silver	\$448
APRPG1GW	2 1/4"	3 3/4"	3"	2	1	Gloss White	\$448

Center grommet top location is standard, cut out top center.

## Occasional Tables

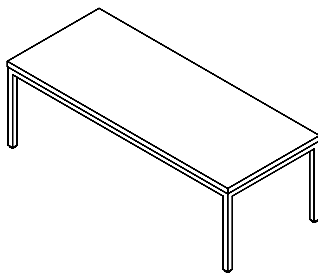

### Coffee Table with Square Metal 4-Leg (1" thick top, 15"H Metal Leg)

Model#	Depth	Width	Height	Leg Color	Weight	Cube	Price
MMCT204816B	20"	48"	16"	Black	39	9	\$642
MMCT204816S	20"	48"	16"	Silver	39	9	\$642
MMCT204816W	20"	48"	16"	White	39	9	\$642
MMCT244816B	24"	48"	16"	Black	44	11	\$706
MMCT244816S	24"	48"	16"	Silver	44	11	\$706
MMCT244816W	24"	48"	16"	White	44	11	\$706

Option to upgrade top to 1 3/4" thick, add MMUTTOP 20% upcharge.

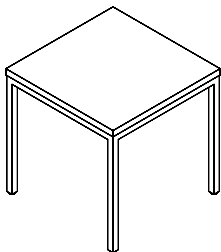

### End Table with Square Metal 4-Leg (1" thick top, 19"H Metal Leg)

Model#	Depth	Width	Height	Leg Color	Weight	Cube	Price
MMET202020B	20"	20"	20"	Black	20	5	\$614
MMET202020S	20"	20"	20"	Silver	20	5	\$614
MMET202020W	20"	20"	20"	White	20	5	\$614
MMET242420B	24"	24"	20"	Black	25	7	\$669
MMET242420S	24"	24"	20"	Silver	25	7	\$669
MMET242420W	24"	24"	20"	White	25	7	\$669

Option to upgrade top to 1 3/4" thick, add MMUTTOP 20% upcharge.

# conference collection

## Data/Power Management

(Cutout locations must be specified. Cutouts are included.)



### Round Power Grommet (1-Power, 2-Power USB, 1-switching adapter, 60" cord)

Model#	Depth	Width	Surface Hold Diameter	Color	Weight	Cube	Price
NAPRGR3B	3 1/2"	3 1/2"	3 3/16"	Black	2	1	\$204
NAPRGR3S	3 1/2"	3 1/2"	3 3/16"	Silver	2	1	\$204

Specify cut-out location for tops, see below.



### Rectangular Power Grommet (1-Power, 2-Power USB with adapter, 108" cord)

Model#	Depth	Width	Height	Color	Weight	Cube	Price
APRPG1B	2 1/4"	3 3/4"	3"	Black	2	1	\$448
APRPG1S	2 1/4"	3 3/4"	3"	Silver	2	1	\$448
APRPG1GW	2 1/4"	3 3/4"	3"	Gloss White	2	1	\$448

Specify cut-out location for tops, see below.



### Plastic Black Power Management Unit (1-Phone, 1-Data, 3-Outlets, 1-Power USB with adapter)

Model#	Dimensions	Color	Weight	Cube	Price
MMPWRDLX	2 7/8"D x 8 3/4"W	Black	2	1	\$459

Black Matte finish. Specify center, left or right cutout location (see below).  
Note: Includes 8 wire-management clips. Includes top cutout (Horizontal).  
Data capability CAT5. Surge protected - 10' cord.



### Metal Power Management Unit (2-Power, 1-Data, 2-Power USB with adapter, 1-HDMI, 1-RJ45, 1-RJ11)

Model#	Dimensions	Color	Weight	Cube	Price
MMPWRDLX2S	5 3/8"D x 9"W	Brushed Silver	2	1	\$1,254
MMPWRDLX2B	5 3/8"D x 9"W	Black	2	1	\$1,254

Metal Silver finish. Specify center, left or right cutout location (see below).  
Note: Includes 8 wire-management clips. Includes top cutout (Horizontal).  
Data capability CAT6. Surge protected - 6' cord.

## Cut Out Locations

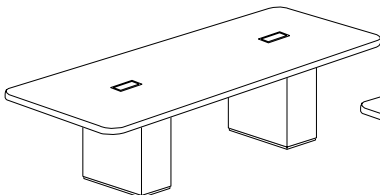

Shown: Left & right cut-out for All power management on this page MMPWRDLX or MMPWRDLX2 (over bases)

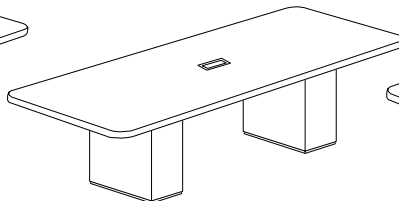

Shown: Center cut-out for All power management on this page

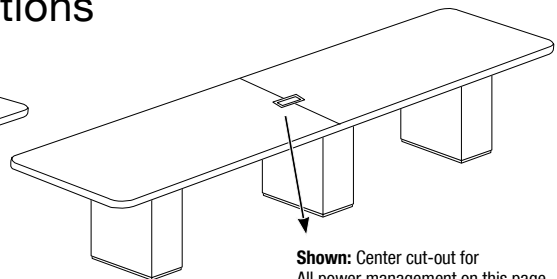

Shown: Center cut-out for All power management on this page MMPWRDLX or MMPWRDLX2 (over base)

**NOTE:** Cut outs are only included with Maverick power units.

# conference collection

## Data/Power Management

(Cut-out locations must be specified. Cutouts are included.)



**Metal Reef Power Management Unit**  
(1-HDMI with adapter, 1-VGA, 1-Audio, 2-RJ45, 3-Power, 2-Power USB with adapter)

Model#	Dimensions	Color	Weight	Cube	Price
MMRPMU16B	6 1/4"D x 16"W	Black	24	2	\$2,111
MMRPMU16S	6 1/4"D x 16"W	Silver	24	2	\$2,111

Includes top cutout (5 3/4"D x 15" W).  
Center cut-out location only horizontal. Cut-out N/A directly over bases (see below).  
Data capability CAT6.



**Metal Black PC Power Management Unit**  
(4-CAT6 Ports, 1-HDMI, 1-VGA, 1-Audio, 12-Outlets and 4-Power USB with adapter)

Model#	Dimensions	Color	Weight	Cube	Price
MMPWRUPCB	9 1/2"D x 30"W	Black	24	2	\$4,928

Includes top cutout (8 1/4"D x 29 1/8"W).  
Center cut-out location only horizontal. Cut-out N/A directly over bases (see below).  
Data capability CAT6.



**Metal Silver Pearl PC Power Management Unit**  
(4-CAT6 Ports, 1-HDMI, 1-VGA, 1-Audio, 12-Outlets and 4-Power USB with adapter)

Model#	Dimensions	Color	Weight	Cube	Price
MMPWRUPCS	9 1/2"D x 30"W	Silver	24	2	\$4,928

Includes top cutout (8 1/4"D x 29 1/8"W).  
Center cut-out location only, horizontal. Cut-out N/A directly over bases (see below).  
Data capability CAT6.

## Cut Out Locations

(Horizontal only, N/A over bases)

**Shown:** Center cut-out between bases  
MMPWRUPCB or MMPWRUPCS  
MMRPMU16B or MMRPMU16S

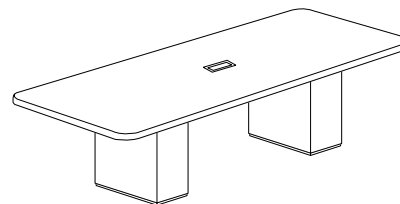
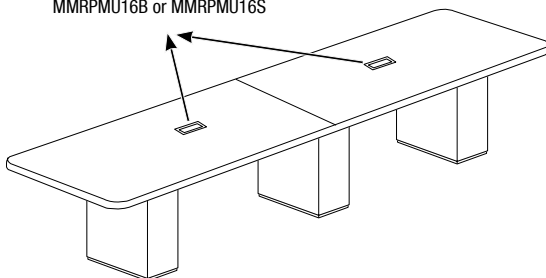

**Shown:** Center cut-out for  
All power management on this page

**NOTE:** Cut outs are only included with Maverick data/power units.

# conference collection

## Conference Room Furnishings

MODEL #					
SERIES (SPECIFY)	DEPTH	WIDTH	HEIGHT	WEIGHT	CUBE

### LIST PRICE BY SERIES (Specify series e.g. MMHDC2036)

MM (Maverick)	MC (Maverick Complete)	CY (Canyon)
------------------	---------------------------	----------------

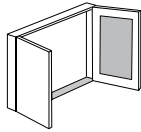

Conference Board						
MMCB36	6"	36"	36"	130	5	\$1,615
MMCB48	6"	48"	48"	130	6	\$1,852

Whiteboard with corkboard provided on inside of both doors.  
**NOTE:** Leaving marker writing on board for more than 48hrs, will result in permanent stains.

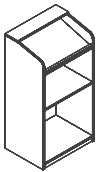

Lectern with Casters						
MMLEC	18"	24"	44"/48"	92	11	\$678

Uses MMCAS standard.

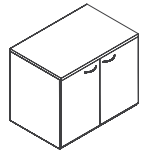

Hinged Door Utility Cabinet (One 3/4"-thick adjustable shelf) H3B Handles						
HDC2036	20"	36"	29"	115	13	\$907
HDC2042	20"	42"	29"	165	15	\$960
HDC2436	24"	36"	29"	175	15	\$1,047
HDC2442	24"	42"	29"	180	18	\$1,133

Optional face lock add MMFL...\$90. Width coordinates with bookcase hutch. See series for standard handle info.

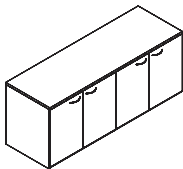

Credenza, Four Full Hinged Doors (Two 3/4"-thick adjustable shelves) H3B Handles						
C2060 1FP	20"	60"	29"	220	21	\$1,824
C2066 1FP	20"	66"	29"	240	23	\$1,981
C2072 1FP	20"	72"	29"	260	25	\$2,006
C2472 1FP	24"	72"	29"	295	30	\$2,181

Optional face lock add MMFL...\$90 each. Two locks required. See series for standard handle info.

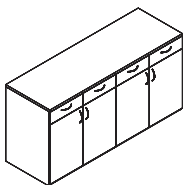

Buffet Credenza (Four box drawers and full hinged doors) H3B Handles						
HDBC2036	20"	36"	36"	220	15	\$1,320
HDBC2436	24"	36"	36"	240	18	\$1,452
HDBC2072	20"	72"	36"	260	30	\$2,736
HDBC2472	24"	72"	36"	290	36	\$2,856

36"w includes one adjustable 3/4" thick shelf, 2 box drawers and 2 full doors.  
 Optional face lock add MMFL...\$90 each (2 are required for 4 doors, 1 for each box drawer).  
 Lock for box drawers N/A for Canyon series.

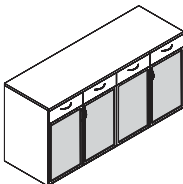

Buffet Credenza (Four box drawers, Full hinged glass doors) H3B Handles						
HDBC2072G	20"	72"	36"	260	30	\$3,728
HDBC2472G	24"	72"	36"	290	36	\$3,846

Storage includes two adjustable 3/4" thick shelf.  
 Optional face lock for box drawers, add MMFL...\$90 each, glass doors do not lock.

For credenzas specifics and other sizes, refer to individual series. For custom sizes, EFQ (Email For Quote).